

Delivering leading edge, innovative power solutions for more than 30 years....

Model:GTM43007-AWWVV-F (D3 without standoffs)

July 24, 2021

2" x 3" (2x3") Ultra Compact AC-DC Switching Power Supplies available in 60601-1 Medical, 60950-1 ITE, and 60335-1 Household with Class I and up to 60W output power DIP without standoffs

Information

Model Number	GTM43007-AWWVV-F (D3 without standoffs)
Description	GTM43007-AWWVV-F (D3 without standoffs), ICT / ITE / Medical Power Supply, 60601-1-4th Ed. , Open Frame/Internal, Regulated Switchmode AC-DC Power Supply AC Adaptor, , Input Rating: 100-240V~, 50-60 Hz, Solder Pins for Line and Neutral, 1.14 mm square pins, 11.43 mm long, Output Rating: 60 Watts, Power rating with convection cooling (W) , 5-48V in 0.1V increments, Approvals: Fuse 60335; Book 60601; CB 60601-1 2MOPP; CB 60950; CB 62368; CB EN/IEC 60335-1; CE; CE; ETL 62368; cETLus ES60601; cETLus; cETLus 60601-1 3rd; China RoHS; Class I; EAC; FCC; Fuse 60335; Level V; NEMKO EN/IEC 60335-1; RoHS; S-Mark IEC/EN 60601-1 60950; Ukraine; WDaE; WEEE; LPS 60950; CCC;
Model Picture	
Agency Documents	http://www.globtek.info/certs/GTM43007/
CE EC-Declaration	https://www.globtek.com/pdf/ec_declaration/a0O0c00000PIXPgEAP
RoHS/RoHS2 Declaration	https://www.globtek.com/pdf/rohs_cert/a0O0c00000PIXPgEAP
REACH Declaration	https://www.globtek.com/pdf/iso_certificates/REACH.pdf
Conflict Minerals Declaration	https://www.globtek.com/pdf/conflict-minerals.pdf

Delivering leading edge, innovative power solutions for more than **30** years....

Model:GTM43007-AWWVV-F (D3 without standoffs)

July 24, 2021

MODEL PARAMETERS

Type	Open Frame/Internal
Technology	Regulated Switchmode AC-DC Power Supply AC Adaptor
Category	ICT / ITE / Medical Power Supply
Input Voltage	100-240V~, 50-60 Hz
I/P Amps (A)	1.5A
Wattage (W)	60.0
Vout Range (V)	5-48
Efficiency Level	N/A
Ingress Protection	N/A
Size (mm)	76.2x50.8x23.6 for 5V-14V models, 76.2x50.8x22.5 for 15V-48V models

Delivering leading edge, innovative power solutions for more than **30** years....

Model:GTM43007-AWWVV-F (D3 without standoffs)

July 24, 2021

ENCLOSURE

GTM43007-A class I OUTLINE DRAWING FOR 5V,9V,12V

Delivering leading edge, innovative power solutions for more than 30 years....

Model:GTM43007-AWWVV-F (D3 without standoffs)

July 24, 2021

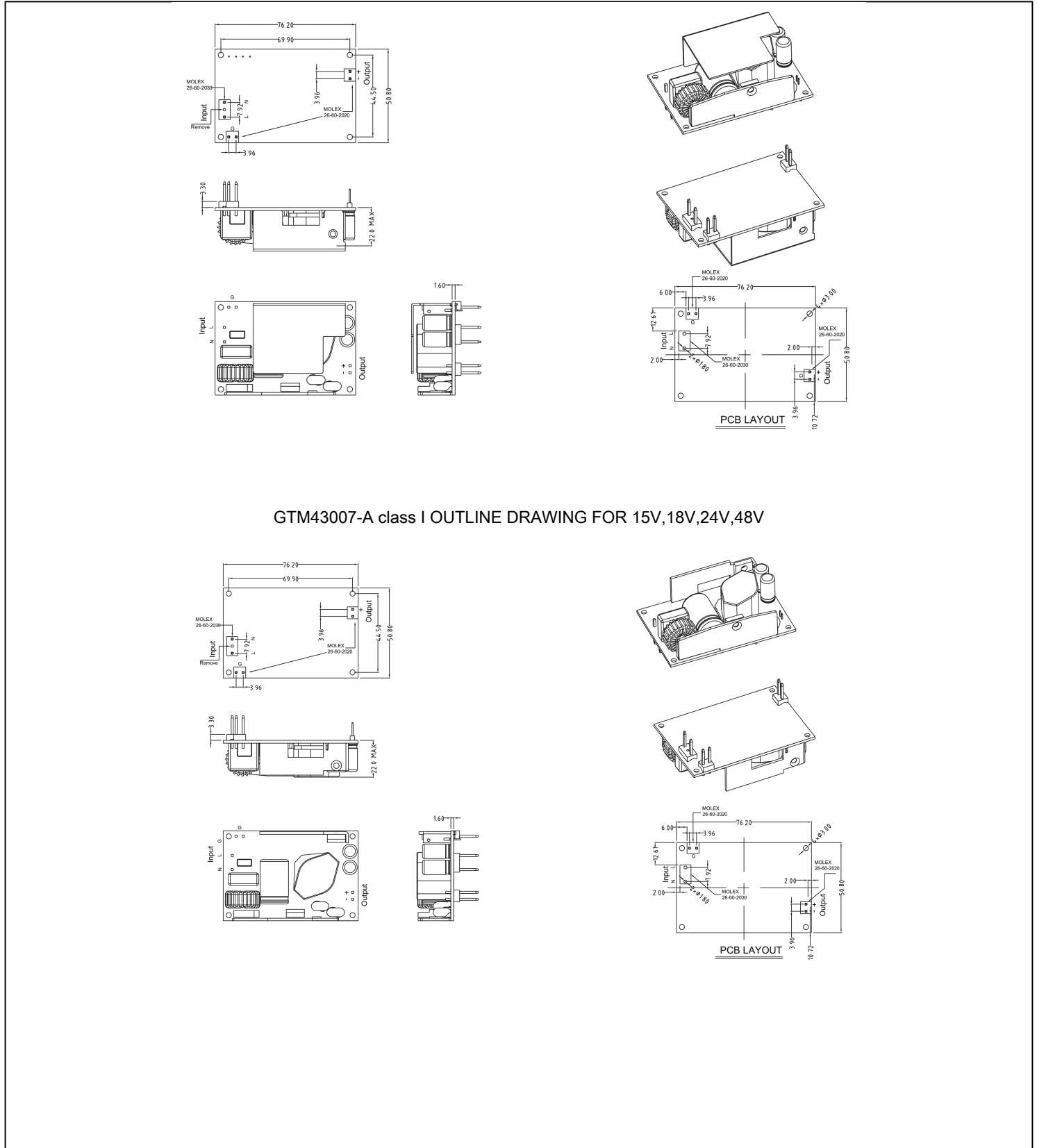

PROPRIETARY INFORMATION

PROPRIETARY OF GLOBTEK, INC. ANY REPRODUCTION, DISCLOSURE OR USE OF THIS DRAWING, IN WHOLE OR IN PART, IS HEREBY PROHIBITED EXCEPT AS SPECIFIED IN WRITING BY GLOBTEK, INC.

<https://en.globtek.com/datasheet/id/a000c00000PIXPg>

Delivering leading edge, innovative power solutions for more than **30** years....

Model:GTM43007-AWWVV-F (D3 without standoffs)

July 24, 2021

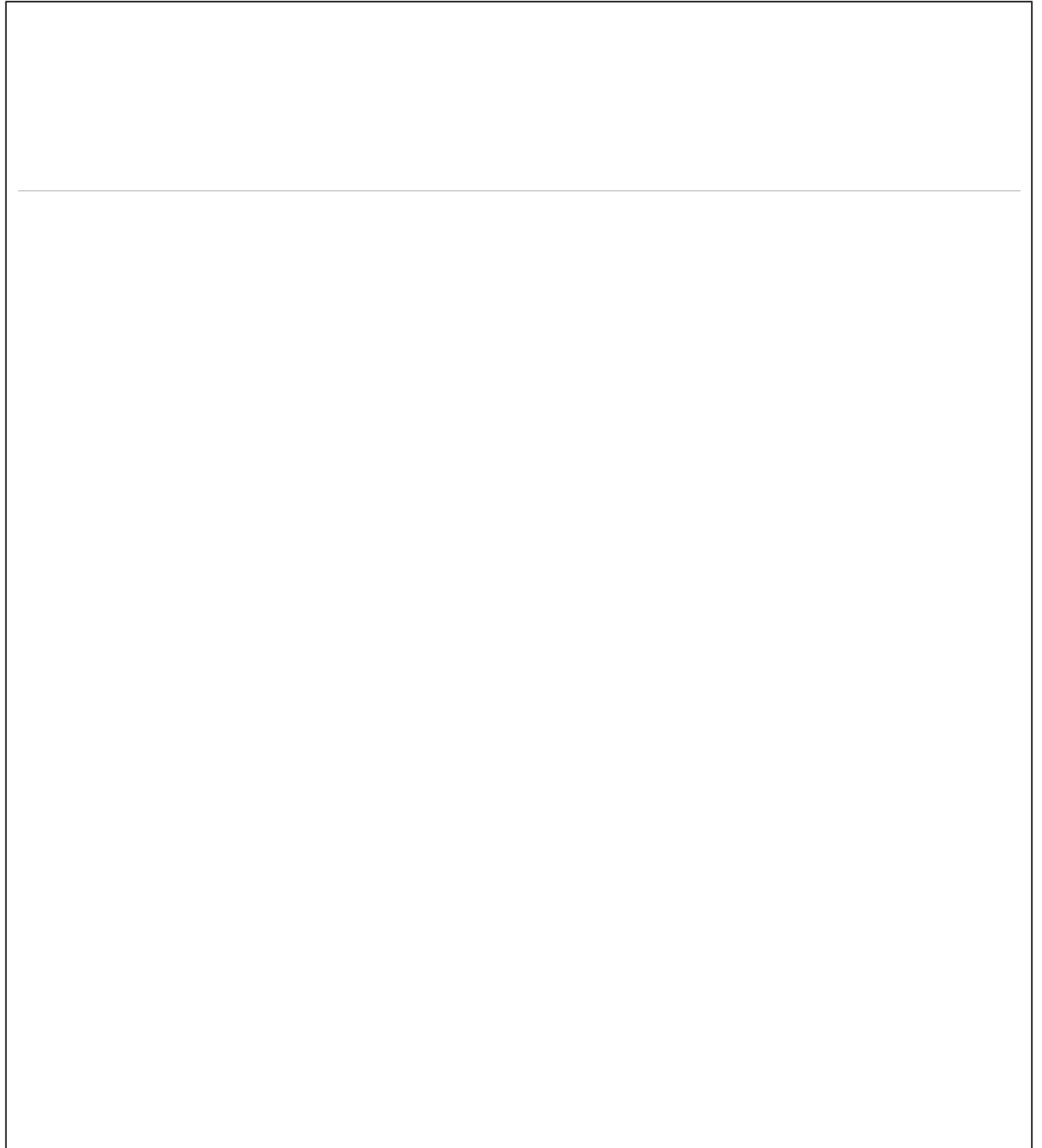

Delivering leading edge, innovative power solutions for more than **30** years....

Model:GTM43007-AWWVV-F (D3 without standoffs)

July 24, 2021

RATING TABLE

Model Number	Voltage	Amps(A)	Watts(W)	RFQ
--------------	---------	---------	----------	-----

SPECIFICATIONS

A) ELECTRICAL SPECIFICATIONS:

01. Input Voltage: Specified 90-264 Vac, Nameplate rated: 100-240Vac
02. Input Frequency: Specified 47-63 Hz, Nameplate rated 50-60Hz
03. Output Regulation: +/- 3% measured at the output connector
04. Line Voltage Regulation: +/- 0.5% maximum measured at full load
05. Output Ripple (Vp-p): 1% or 150 mV whichever is greater, measured at 20 MHz bandwidth with 0.1 uf ceramic capacitor in parallel with a low impedance 47 uf electrolytic capacitor connected 3" from the output connector .
06. Turn-ON/OFF: 5% maximum, 1 mS typical recovery time for 25% step load
07. Turn-ON Delay: 3 Sec max
08. Hold-Up Time: 8 mS typical @ nominal input voltage and full load
09. Inrush Current: 30A maximum @ 115 Vac input, 60A maximum @ 230 Vac input
10. Switching Frequency: 65 KHz typical
11. Efficiency: 87% @ 115Vac, 89% @ 230Vac typical at full load
12. No Load Power: < 300mW @ 230Vac

B) PROTECTION

01. Overvoltage Protection: 110% to 130% of nominal output voltage, and less than 60Vdc
02. Short Circuit/Over-load: momentary short circuit protected, output will auto recover upon removal of short
03. Input Protection: Input line fusing and 300Vac MOV

C) SAFETY

01. Dielectric Withstand Voltage: 4000Vac / 5656Vdc from primary to secondary
02. [Output Isolation Options](#): Class I or Class II
03. Earth Leakage Current: Does not exceed 300uA in NORMAL CONDITION and 1000uA in SINGLE FAULT CONDITION
04. Output Leakage Current: Does not exceed 75uA NC(Normal condition) 300uA SFC(single fault condition)
05. Means of Protection: 2 x MOPP
06. Compliant Standards: See listings at end of this drawing for specifics

D) EMC

EN 60601-1-2, 4th edition

Emissions, per EN 55032, EN 61000-6-3, EN 61000-6-4, CISPR11 and CISPR22

Conducted Emissions: Class B, FCC Part 15, Class B

Radiated Emissions: Class B, FCC Part 15, Class B

Line Frequency Harmonics EN61000-3-2, Class A

Voltage Fluctuations/Flicker EN61000-3-3

Immunity, per EN 55024, EN 61000-6-1, EN 61000-6-2

Static Discharge Immunity EN61000-4-2, 10kV Contact Discharge, 20kV air discharge

Radiated RF Immunity EN61000-4-3, 10V/m 80-1000MHz, 3V/m 1-2.7GHz, 80% 1KHz AM.

EFT/Burst Immunity EN61000-4-4, 4kV/100kHz.

Line Surge Immunity EN61000-4-5, 2kV differential, 4kV common-mode

Conducted RF Immunity EN61000-4-6, 3Vrms, 80% 1KHz AM

Power Frequency Magnetic Field Immunity EN61000-4-8, 3A/m

Voltage Dip Immunity EN61000-4-11, Criteria

PROPRIETARY INFORMATION

PROPRIETARY OF GLOBTEK, INC. ANY REPRODUCTION, DISCLOSURE OR USE OF THIS DRAWING, IN WHOLE OR IN PART, IS HEREBY PROHIBITED EXCEPT AS SPECIFIED IN WRITING BY GLOBTEK, INC.

<https://en.globtek.com/datasheet/id/a000c00000PIXPg>

Delivering leading edge, innovative power solutions for more than **30** years....

Model:GTM43007-AWWVV-F (D3 without standoffs)

July 24, 2021

E) OTHER

01. MTBF: 1,000,000 Hours @ 45°C ambient temperature, Full Load
02. Operating Temperature: -10°C to 45°C ambient temperature
03. Humidity: 0% to 95% relative humidity
04. Storage Temperature: -30°C to 80°C
05. Cooling: Convection
06. Elevation: 5000M
07. ROHS 2: Complies with EU 2011/65/EU and China SJ/T 11363-2006

F) MECHANICAL FORMAT

01. Type: Open Frame
02. Size: A suffix version, (2"x3"), 76.2 x 50.8 x 30.5 mm
03. Size: B suffix version, (2"x4"), 101.6 x 50.8 x 30.5 mm
04. Size: C suffix version, (3"x5"), 127.0 x 76.2 x 30.5 mm

G) SPECIAL OPTIONS

01. Custom Label Markings
 02. Short term Output Surge Capability
 03. Reduced Leakage Current versions
 04. Tightened output voltage tolerance
 05. Reduced output ripple level
 06. High Rel PCB laminate with Plated through Holes for IPC610 Class 2 Compliance
 07. Low Temperature operation, down to -40°C
 08. Quasi Constant Current Output, for Lead-Acid Battery Charger Applications
 09. Special Input or Output Connectors
 10. Over-Temperature Protection, Latched Shut-Down
-

Delivering leading edge, innovative power solutions for more than 30 years....

Model:GTM43007-AWWVV-F (D3 without standoffs)

July 24, 2021

DERATING CURVE

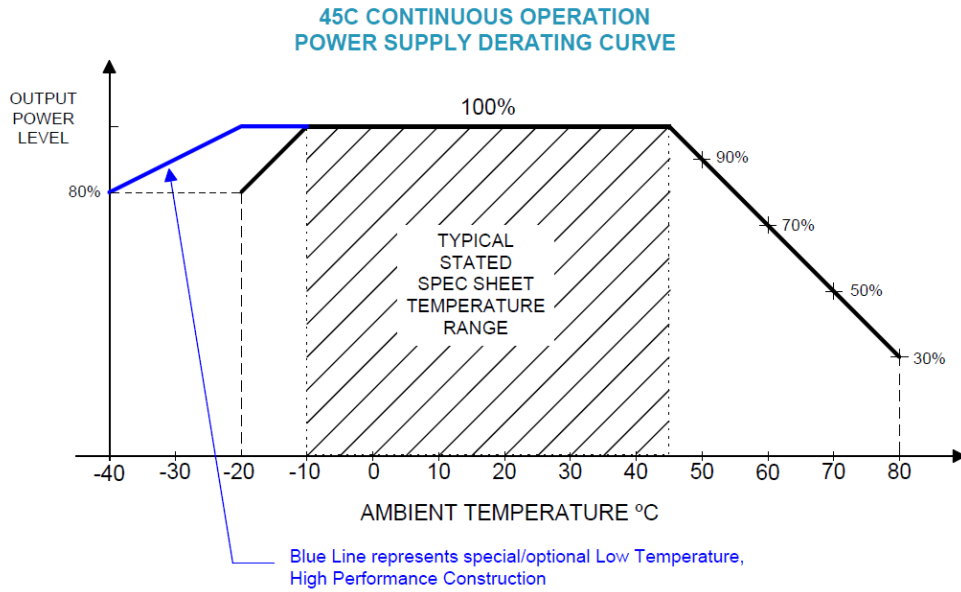

Delivering leading edge, innovative power solutions for more than **30** years....

Model:GTM43007-AWWVV-F (D3 without standoffs)

July 24, 2021

INPUT CONFIGURATION

Description	Solder Pins for Line and Neutral, 1.14 mm square pins, 11.43 mm long
-------------	----------------------------------------------------------------------

Delivering leading edge, innovative power solutions for more than 30 years....

Model:GTM43007-AWWVV-F (D3 without standoffs)

July 24, 2021









Approvals

Logo	Description
	Book 60335 up to 36 Volts
	60601-1 3rd Operating Instructions
No Logo Applicable	CB report IEC60601-1 2005 A1+C1+C2 2016-2-4 and or EN 60601-1:2006 3.1rd Edition 2xMOPP
No Logo	CB Report EN60950-1
No Logo Applicable	CB for IEC 62368-1:2014 (Second Edition)
No Logo Applicable	CB to 60335-1 5th Edition (Safety of Household and Similar Electrical Appliances, Part 1: General Requirements) CB Report/ Certificate IEC 60335-1:2010 Up to 36 volts only
	CCC Altitude up to 5000 m GB17625.1-2012, GB4943.1-2011, GB/T9254-2008 for GT*43007
	CE Certification CE Mark: tested to comply with EN 55032.2012+AC.2013 EN 61000-3-2.2014 EN 61000-3-3.2013 EN 60601-1-2.2015 EN 55024.2010
	CE Mark: tested to comply with EN 60601-1-2:2015 Medical electrical equipment Part 1-2: - Mark is on the label or Molded in the case
	Audio/Video, Information And Communication Technology Equipment - Part 1: Safety Requirements [UL 62368-1:2014 Ed.2] Audio/Video, Information And Communication Technology Equipment - Part 1: Safety Requirements [CSA C22.2#62368-1:2014 Ed.2]
Conforms to ANSI/AAMI ES 60601-1:2005 Cert.to CAN/CSA Std. C22.2	cETLus ANSI_AAMI ES60601-1_2005

Delivering leading edge, innovative power solutions for more than 30 years....

Model:GTM43007-AWWVV-F (D3 without standoffs)



July 24, 2021

Conforms to ANSI/UL Std. 60950-1 Cert. to CAN/CSA Std. C22.2 NO. 60950-1	Conforms to ANSI/UL Std. 60950-1 2nd Edition Cert. to CAN/CSA Std.C22.2 NO.60950-1 2nd Edition
	cETLus-Cert-4007497 ANSI/AAMI ES60601-1:2005 with AMD C1: 2009, AMD C2: 2010 and CAN/CSA-C22.2 No. 60601-1 2008 with COR 2:2011+ANSI/AAMI HA60601-1-11 Ed:1
	CHINA SJ/T 11364-2014, China RoHS Chart: http://en.globtek.com/globtek-rohs.php
Conforms to UL STD. 62368-1 Certified to CSA STD C22.2 NO.62368-1	Conforms to UL STD. 62368-1 Certified to CSA STD C22.2 NO.62368-1
	Declaration ДС № EAЭC N RU Д-US.KA01.B.10453_19 Custom Union of Russia, Belarus and Kazakhstan http://www.globtek.com/redirect/?loc=gost-certificate-eac-declaration
	FCC PART 15 CLASS B
T2.0A 250VAC 	Fuse 60335 T2.0A 250VAC Up to 36 volts
	Indoor Use Only - Mark is on the label or Molded in the case
EFFICIENCY LEVEL 	Efficiency: complies to section 301 of Energy Independence and Security Act (EISA) complies with Energy Star tier 2 (North America), ECP tier 2 (China), MEPS tier 2 (Australia), Code of Conduct (Europe)
LPS	Limited Power Source 60950
	NEMKO IEC/EN 60335-1 (Safety of Household and Similar Electrical Appliances, Part 1: General Requirements) up to 36 Volts
RoHS	Specifications of directive 2011/65/EU Annex VI (ROHS-2) with amendment 2015/863-EU (ROHS-3) http://www.ce-mark.com/Rohs%20final.pdf

Delivering leading edge, innovative power solutions for more than **30** years....

Model:GTM43007-AWWVV-F (D3 without standoffs)

July 24, 2021

 Intertek IEC/EN60601-1 IEC/EN60950-1	Semko S-Mark-Cert-EN60601-1 and EN60950-1
 10276	Ukraine UKRSepr (Document: www.globtek.com/html/iso_certificates/GT_Ukraine.pdf)
WDaE	Appliances can be used in warm damp equable climates
	WEEE: Complies with EU 2012/19/EU (http://ec.europa.eu/environment/waste/weee/index_en.htm) Mark is on the label or Molded in the case