

Delivering leading edge, innovative power solutions for more than 30 years....

Model:GT-46600-WWVV-X.X-T2

October 15, 2021

**DOE EPS 2.0 Level VI Power Supply / Charger / AC Adapter, 60W Desktop/Tabletop,
Available with 5-24VDC output Certified to 60950 ITE Standards**

Information

Model Number	GT-46600-WWVV-X.X-T2
Description	60 W, DoE Level VI & CoC Tier 2 Efficiency, Two Prong (C8) Inlet, Desktop Adapter, Ac-Dc Power Supply

Model Picture

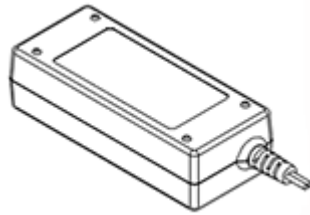

Agency Documents	http://www.globtek.info/certs/GT-46600-60VV-X.X/
CE EC-Declaration	https://www.globtek.com/pdf/ec_declaration/a0Oa000000MikA1EAJ
RoHS/RoHS2 Declaration	https://www.globtek.com/pdf/rohs_cert/a0Oa000000MikA1EAJ
REACH Declaration	https://www.globtek.com/pdf/iso_certificates/REACH.pdf
Conflict Minerals Declaration	https://www.globtek.com/pdf/conflict-minerals.pdf

Delivering leading edge, innovative power solutions for more than **30** years....

Model:GT-46600-WWVV-X.X-T2

October 15, 2021

MODEL PARAMETERS

Type	Desktop/External
Technology	Regulated Switchmode AC-DC Power Supply AC Adaptor
Category	ICT/ITE Power Supply
Input Voltage	100-240V~, 50-60 Hz
I/P Amps (A)	1.5A
Wattage (W)	60.0
Vout Range (V)	12-24
Efficiency Level	USA DOE Level VI / Eco-design Directive 2009/125/EC, (EU) 2019/1782
Ingress Protection	IPX0
Size (mm)	121*52*33

PROPRIETARY INFORMATION

PROPRIETARY OF GLOBTEK, INC. ANY REPRODUCTION, DISCLOSURE OR USE OF THIS DRAWING, IN WHOLE OR IN PART, IS HEREBY PROHIBITED EXCEPT AS SPECIFIED IN WRITING BY GLOBTEK, INC.

<https://en.globtek.com/datasheet/id/a0Oa000000MikA1>

Delivering leading edge, innovative power solutions for more than **30** years....

Model:GT-46600-WWVV-X.X-T2

October 15, 2021

ENCLOSURE

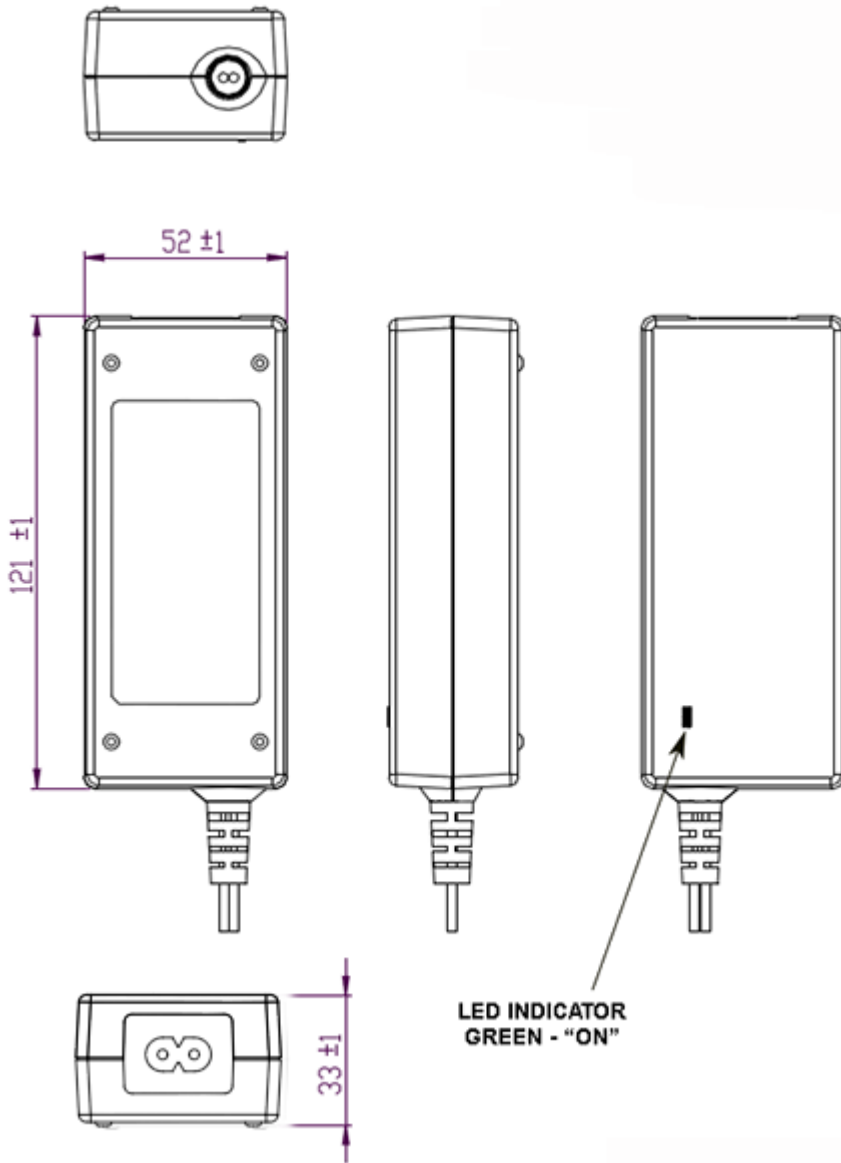

Delivering leading edge, innovative power solutions for more than 30 years....

Model:GT-46600-WVVV-X.X-T2

October 15, 2021

RATING TABLE

Model Number	Voltage	Amps(A)	Watts(W)	RFQ
GT-46600-6012-T2	12 V	5	60.00	RFQ
GT-46600-6015-2.0-T2	13 V	4.61	59.93	RFQ
GT-46600-6015-2.0-T2	14 V	4.28	59.92	RFQ
GT-46600-6015-T2	15 V	4	60.00	RFQ
GT-46600-6024-8.0-T2	16 V	3.75	60.00	RFQ
GT-46600-6024-7.0-T2	17 V	3.52	59.84	RFQ
GT-46600-6024-6.0-T2	18 V	3.34	60.12	RFQ
GT-46600-6024-5.0-T2	19 V	3.15	59.85	RFQ
GT-46600-6524-5.0-T2	19 V	3.42	64.98	RFQ
GT-46600-6524-4.0-T2	20 V	3.25	65.00	RFQ
GT-46600-6524-3.0-T2	21 V	3.09	64.89	RFQ
GT-46600-6524-2.0-T2	22 V	2.95	64.90	RFQ
GT-46600-6524-1.0-T2	23 V	2.82	64.86	RFQ
GT-46600-6524-T2	24 V	2.7	64.80	RFQ
GT-46600-6024-T2	24 V	2.5	60.00	RFQ

Delivering leading edge, innovative power solutions for more than 30 years....

Model:GT-46600-WWVV-X.X-T2

October 15, 2021

SPECIFICATIONS

A) ELECTRICAL SPECIFICATIONS:

01. Input Voltage: Specified 90-264 Vac, Nameplate rated: 100-240Vac
02. Input Frequency: Specified 47-63 Hz, Nameplate rated 50-60Hz
03. Input Rated Current: 1.5A RMS Max
04. Inrush Current: No damage at 240VAC Cold Start
05. Average Efficiency: 88% Min (CEC & DOE LEVEL VI Compliant); 89% Min (ErP Tier2 Compliant)
06. Input Power(no load): <0.21W (CEC &DOE Level VI Compliant); <0.15W (ErP Tier2 Compliant)
07. Line regulation: $\pm 1\%$
08. Ripple Voltage: 200mV (p-p) (100-240V AC Input). Measuring is done by 20MHz bandwidth oscilloscope and terminated each output with a 10uf aluminum electrolytic capacitor and 0.1uf ceramic capacitor.

B) PROTECTION

01. Over-Voltage: Electronically Protected Zener clamp across the output
02. Short Circuit: Electronically Protected unit will auto recover upon removal of fault
03. Over Temperature Protection: There shall be no ignition or smoke and deformation of case
04. 08. Over voltage protection: for 12V - 16V; for 15V - 20.25V, for 19V - 25.65, for 24V - 32.4V

C) SAFETY

01. Dielectric Withstand Voltage: 4242Vdc from primary to secondary
02. Touch Current: <0.25mA @ 240Vac input voltage
03. ROHS 2: Complies with EU 2011/65/EU and China SJ/T 11363-2006

D) OTHER:

01. MTBF: 1,500,000 hours @ 25°C ambient, full load (Telcordia SR-332, Issue 3)
02. Operating Temperature: 0°C to 40°C ambient temperature
03. Humidity: 10% to 90% relative humidity
04. Storage Temperature: -20°C to 70°C
05. Cooling: Convection
06. ROHS 2: Complies with EU 2011/65/EU and China SJ/T 11363-2006

E) ENCLOSURE

01. Housing: High impact plastic, 94V0 polycarbonate, non-vented
02. Size: 121*52*33 +/-1.0 mm
03. Markings: Label and/or Pad Printed and/or Molded in the case

PROPRIETARY INFORMATION

PROPRIETARY OF GLOBTEK, INC. ANY REPRODUCTION, DISCLOSURE OR USE OF THIS DRAWING, IN WHOLE OR IN PART, IS HEREBY PROHIBITED EXCEPT AS SPECIFIED IN WRITING BY GLOBTEK, INC.

<https://en.globtek.com/datasheet/id/a0Oa000000Mika1>

Delivering leading edge, innovative power solutions for more than 30 years....

Model:GT-46600-WWVV-X.X-T2

October 15, 2021

DERATING CURVE

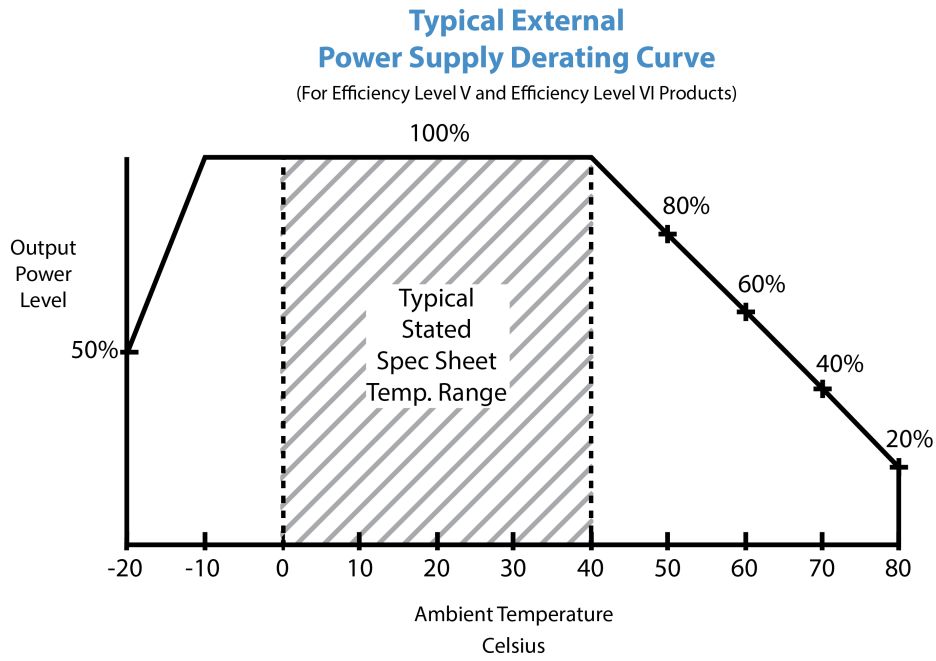

Delivering leading edge, innovative power solutions for more than 30 years....

Model:GT-46600-WVVV-X.X-T2

October 15, 2021

INPUT CONFIGURATION

Description IEC 60320/C8 AC Inlet connector, Class II, Non-Earth Ground (aka "Figure-8")

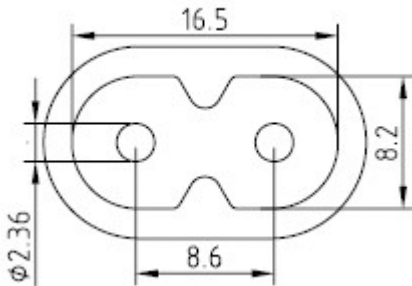

Mates with IEC 60320/C7 Plug

Below are standard cordsets which are "not included" (unless stated above); these may be purchased separately or packaged with the power supply. Please contact your Sales Engineer if the style required is not shown below. Many more available in different lengths, colors or cable material.

[Standard International IEC 320/C7 Cordsets](#)

Part Number	Type	Standard	Connector	Length (mm)	Length (feet)
2094112M703(R)	Argentina (Type I)	IRAM 2063	IEC 320/C7	2000	7
5014112M703A(R)	Australian (Type I)	AS 3112	IEC 320/C7	2000	7
207B4111M8703(R)	Brazil (Type N)	NBR14136	IEC 320/C7	1800	6
4533501M8703(R)	China (Type A)	GB 2099.1	IEC 320/C7	1830	6
2074112M703A(R)	European (Type C)	CEE 7/16	IEC 320/C7	2000	7
2084111M8703B(R)	India (Type D)	IS 1293	IEC 320/C7	1800	6
451J3401M8703(R)	Japan (Type A)	JIS 8303	IEC 320/C7	1830	6
2044112M703A(R)	Korea (Type C)	KS C8305	IEC 320/C7	2000	7
4511116F703A(R)	North America (Type A)	NEMA 1-15P	IEC 320/C7	1830	6
	South Africa (Type				

Delivering leading edge, innovative power solutions for more than **30** years....

Model:GT-46600-WVVV-X.X-T2

October 15, 2021

2084111M8703(R)	M)	BS 546	IEC320/C7	1830	6
4033401M8703A(R)	Taiwan (Type A)	CNS690	IEC 320/C7	1830	6
6104112M703A(R)	UK, Hong Kong, Singapore, Gulf States (Type G)	BS1363	IEC 320/C7	2000	7
451G1116F703A(R)	Gulf States (Kuwait, Bahrain, Oman, Qatar, Saudi Arabia, Yemen and the United Arab Emirates (UAE)(Type A)	Nema 1-15P	IEC320/C7	1830	6

Delivering leading edge, innovative power solutions for more than 30 years....

Model:GT-46600-WWVV-X.X-T2

October 15, 2021

OUTPUT CONFIGURATION

Common output connector options:

 L Type (Coaxial
5.5x2.5mm plug)

 C Type (Coaxial
5.5x2.1mm plug)

 K Type (Coaxial
3.5x1.3mm plug)

 LL Type (5.5x2.5mm
Locking 760k type)

 CL Type (5.5x2.1mm
Locking S761k type)

 ML2 Type (Molex
housing 43025-0200)

 YL3 Type
(KPPX-3P)

YL4 Type (KPPX-4P)

 EJ1/2/3/4/5 (EIAJ
RC-5320A type
connectors)

 MSB Type (Micro
USB)

 USBC Type (USB
Type C)

 Inquire for custom
design

 For a comprehensive list of options, [click here](#)

Contact GlobTek for your specific requirements or custom solutions.

Delivering leading edge, innovative power solutions for more than **30** years....

Model:GT-46600-WWVV-X.X-T2

October 15, 2021









Approvals

Logo	Description
No Logo Applicable	EU 230V CoC Tier 2, 278/2009, Mar 2014
No Logo Applicable	IEC 60335-1:2010+A1+A2
No Logo Applicable	IEC 60950-1:2005 +A1:2009 +A2:2013
No Logo Applicable	CB for IEC 62368-1:2014 (Second Edition)
	CCC to GB4943.1-2011; GB/T9254-2008 GB17625.1-2012, Tropical <2000
	CE Certification Class II CE Mark: tested to comply with EN 55032.2012+AC.2013 EN 61000-3-2.2014 EN 61000-3-3.2013 EN 55024.2010
	CE Mark: tested to comply with EN55022:2006/A1:2007 Class B, EN610003-2, EN610003-3 including EN61000-4-2, EN61000-4-3, EN61000-4-4, EN61000-4-5, EN61000-4-6N EN61000-4-11; EMI: Complies with EN55011 CLASS B and FCC Part 15B - On label or Molded in case
	CHINA SJ/T 11364-2014, China RoHS Chart: http://en.globtek.com/globtek-rohs.php
Conforms to UL STD. 62368-1 Certified to CSA STD C22.2 NO.62368-1	Conforms to UL STD. 62368-1 Certified to CSA STD C22.2 NO.62368-1
	UL60950-1, cULus to UL 60950-1 E170507
	

Delivering leading edge, innovative power solutions for more than 30 years....

Model:GT-46600-WWVV-X.X-T2

October 15, 2021

	Declaration ДС № EAЭC N RU Д-US.KA01.B.10453_19 Custom Union of Russia, Belarus and Kazakhstan http://www.globtek.com/redirect/?loc=gost-certificate-eac-declaration
	Compliance of this power supply with FCC Part 15, Class B has been demonstrated with a standard output load. The FCC law stipulates that system-level testing is required to demonstrate compliance with the FCC emission limits with the actual system load.
	Indoor Use Only - Mark is on the label or Molded in the case
 Glob Tek, Inc.	JAPAN TUV R-PSE, Cert. No. JD 50469658, to J62368-1(H30) , J55032(H29),J3000(H25)[15V or less]. Please reference the following website for guidelines on PSE regulations: http://en.globtek.com/importing-ite-and-medical-power-supplies-ac-adaptors-to-japan/
EFFICIENCY LEVEL 	Efficiency: complies to section 301 of Energy Independence and Security Act (EISA) complies with Energy Star tier 2 (North America), ECP tier 2 (China), MEPS tier 2 (Australia), Code of Conduct (Europe)
LPS	Limited Power Source 60950
No Logo	Malaysia ST Release Letter GT-46600 T2 -T3A IEC60950-1(Ed.2): 2005 + A1:2009 + A2:2013 No logo
	Morocco SDoC declaration http://www.globtek.info/certs/Morocco%20SDoC%20Declaration/
 Energy Verified Rendement Énergétique Vérifié	NRCAN Nemko for GT-46600-6012 (12V output) and GT-46600-6015 (15V output) only Natural Resources Canada (NRCAN): CSA Standard C381.1-08, QSP NRCAN EEV1191; http://shop.csa.ca/en/canada/energy-efficiency/canca-c3811-08/invt/27024802008
 Glob Tek, Inc.	JAPAN TUV Rheinland-PSE GlobTek Inc to J60950-1(H26) , J55022(H22),J3000(H25).Please follow the procedure listed in the following link for proper import to Japan: http://en.globtek.com/importing-to-japan.php .

Delivering leading edge, innovative power solutions for more than 30 years....

Model:GT-46600-WVVV-X.X-T2

October 15, 2021

 SAA-210728-EA	RCM certificate SAA-210728-EA; Australia and New Zealand Regulatory Compliance, Mark (http://rcm.standards.org.au/rcmfaq/rcmfaq.htm)
RoHS	Specifications of directive 2011/65/EU Annex VI (ROHS-2) with amendment 2015/863-EU (ROHS-3) http://www.ce-mark.com/Rohs%20final.pdf
إمدادات الطاقة	Saudi Arabia approval GT-46600-60VV-X.X-T3 IEC 60950-2005 (output voltage range is 12-24V)
	UKCA Certification
 10276	Ukraine UKR Sepro (Document: www.globtek.com/html/iso_certificates/GT_Ukraine.pdf)
	UL 62368-1 and CAN/CSA C22.2 No. 62368-1-14
	Japan: Voluntary Control Council for Interference (VCCI)
	WEEE: Complies with EU 2012/19/EU (http://ec.europa.eu/environment/waste/weee/index_en.htm) Mark is on the label or Molded in the case