

Delivering leading edge, innovative power solutions for more than 30 years....

Model:GTM961200P120VV.V-T3

October 15, 2021

GlobTek's GTM961200 series of external tabletop/desktop power supplies offer up to 120W of power while offering compliance to the latest ITE, Medical, Household, and Efficiency requirements.

Information

Model Number	GTM961200P120VV.V-T3
Description	120 W, DoE Level VI & CoC Tier 2 Efficiency, Three Prong (C14) Inlet, Desktop Adapter, Ac-Dc Power Supply

Model Picture



Agency Documents	http://www.globtek.info/certs/GTM961200P/
CE EC-Declaration	https://www.globtek.com/pdf/ec_declaration/a0Oa000000MjJKDEA3
RoHS/RoHS2 Declaration	https://www.globtek.com/pdf/rohs_cert/a0Oa000000MjJKDEA3
REACH Declaration	https://www.globtek.com/pdf/iso_certificates/REACH.pdf
Conflict Minerals Declaration	https://www.globtek.com/pdf/conflict-minerals.pdf

Delivering leading edge, innovative power solutions for more than **30** years....

Model:GTM961200P120VV.V-T3

October 15, 2021

MODEL PARAMETERS

Type	Desktop/External
Technology	Regulated Switchmode AC-DC Power Supply AC Adaptor
Category	ICT / ITE / Medical Power Supply
Input Voltage	100-240V~, 50-60 Hz
I/P Amps (A)	1.5 A
Wattage (W)	120.0
Vout Range (V)	12-54
Efficiency Level	USA DOE Level VI / Eco-design Directive 2009/125/EC, (EU) 2019/1782
Ingress Protection	IP41
Size (mm)	149.30*62.80*34.00

PROPRIETARY INFORMATION

PROPRIETARY OF GLOBTEK, INC. ANY REPRODUCTION, DISCLOSURE OR USE OF THIS DRAWING, IN WHOLE OR IN PART, IS HEREBY PROHIBITED EXCEPT AS SPECIFIED IN WRITING BY GLOBTEK, INC.

<https://en.globtek.com/datasheet/id/a0Oa000000MjJKD>

Delivering leading edge, innovative power solutions for more than 30 years....

Model:GTM961200P120VV.V-T3

October 15, 2021

ENCLOSURE

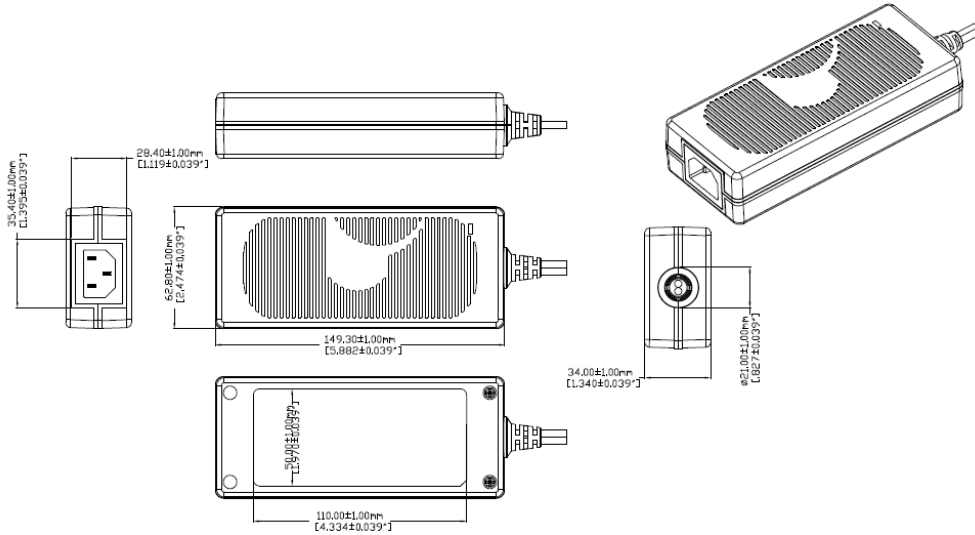

Alternative housing with input cord clamp to prevent accidental removal of the power cord. Product PN# ends with suffix "CL"

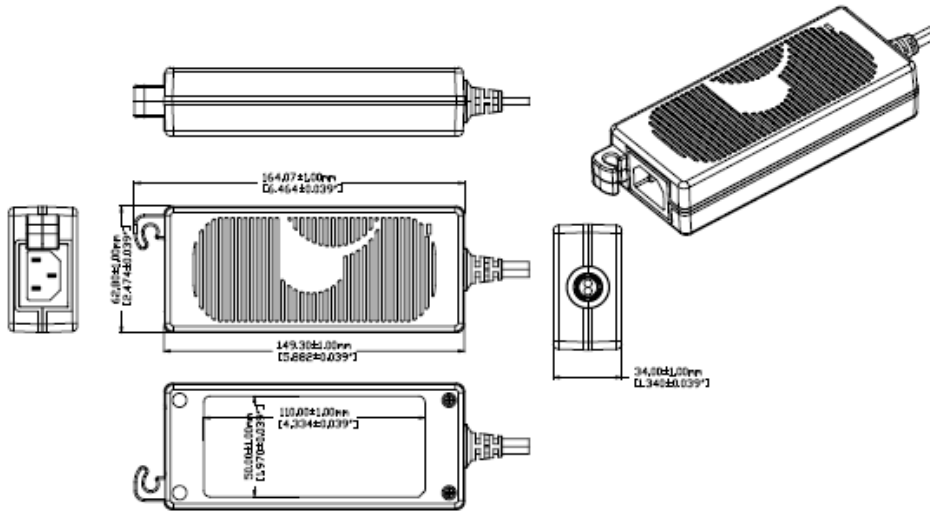

Delivering leading edge, innovative power solutions for more than **30** years....

Model:GTM961200P120VV.V-T3

October 15, 2021

RATING TABLE

Model Number	Voltage	Amps(A)	Watts(W)	RFQ
GTM961200P11012-T3	12 V	9.2	110.40	RFQ
GTM961200P10812-T3	12 V	9	108.00	RFQ
GTM961200P12015-T3	15 V	8	120.00	RFQ
GTM961200P10019-T3	19 V	5.263	100.00	RFQ
GTM961200P12019-T3	19 V	6.316	120.00	RFQ
GTM961200P12024-T3	24 V	5	120.00	RFQ
GTM961200P12028-T3	28 V	4.28	119.84	RFQ
GTM961200P12030-T3	30 V	4	120.00	RFQ
GTM961200P12036-T3	36 V	3.33	119.88	RFQ
GTM961200P12038-T3	38 V	3.15	119.70	RFQ
GTM961200P12048-T3	48 V	2.5	120.00	RFQ
GTM961200P12054-T3	54 V	2.22	119.88	RFQ

Model:GTM961200P120VV.V-T3

October 15, 2021

SPECIFICATIONS

Input

Input Voltage:	Specified: 90-264VAC, Nameplate: 100-240VAC 100% rated load current for 90-264VAC 90% rated load current for 85-264VAC 100% rated load current for 90-370VDC
Input Frequency:	Specified: 47-63Hz, Nameplate: 50-60Hz
Power Factor:	0.90 min. @ 230VAC, 0.97 min. @ 115VAC
No Load Input Power:	< 150mW @ 115/230VAC
Inrush Current:	< 65A @ 115VAC, < 130A @ 230VAC (cold start)
Efficiency:	DoE Level VI and EU CoC Tier 2 compliant

Output

Turn-on Delay:	1 second typ.
Output Regulation:	± 4% (measured at output connector)
Line Regulation:	± 0.5% typ. (measured at output connector, full load)
Ripple:	1% or 200mV, whichever is greater (using a 47µF low-ESR cap + 0.1µF ceramic capacitor, measured @ 20MHz BW, at output connector)
Startup Overshoot:	5% max.
Transient Response:	5% max. deviation, 1ms typ. recovery time (with 25% to 50% load step)
Hold-up Time:	20ms min.
Power Indicator:	Green LED
Switching Frequency:	Variable, 25KHz - 125KHz, depending on load

Protections

Input Protection:	300VAC MOV transient suppressor, input line fusing
Over-Current Protection	Current limited to less than $< 170W / V_{out(nom.)}$ and $< 13A$, auto-restart
Short-Circuit Protection:	Auto-restart
Over-Voltage Protection:	110 - 135% (60V max for models rated 45 - 54V), full load condition, latched off, cycle AC to reset
Over-Temperature Protection	Internal ambient NTC temperature sensor, latched off, cycle AC to reset

Environmental

MTBF:	1,500,000 hours @ 25°C ambient, full load (Telcordia SR-332, Issue 3)
Operating Temperature:	-10°C to 40°C (full load)
Storage Temperature:	-30°C to 80°C

Delivering leading edge, innovative power solutions for more than 30 years....

Model:GTM961200P120VV.V-T3

October 15, 2021

Humidity:	0% to 95% relative humidity, non-condensing
Altitude:	5000m
Cooling:	Convection
RoHS:	Complies with EU 2011/65/EU and China SJ/T 11363-2006
Note 1:	Regarding operating temperature a. See below de-rating table for output power capability at alternate temperature b. Extended low-end temperature range available as a custom option

Safety

Dielectric Withstand Voltage:	4000VAC or 5656VDC from input to output 3000VAC or 4242VDC from input to earth (Class I models only)
Touch Current:	Class I: 20μA max. Class II: 70μA max.
Earth Leakage Current	Class I: 300μA max. Class II: N/A
Means of Protection:	2 x MOPP
Output Isolation Options:	Class I: C6 or C14 inlet (output negative tied to Earth contact) Class II: C8 or C18 inlet Class II FE: C6 or C14 inlet (output isolated from Earth contact) Review isolation options by reading our white paper PSU Isolation and Identity .
Primary-to-Secondary Bridging Capacitors:	Two IEC60384-14 Class Y1 capacitors
Earth Continuity Test:	< 0.1Ω between earth pin (on AC inlet) and PCB termination point (Class I models only)
Compliant Standards:	See listing at end of this datasheet for specific standards

EMC

Applicable Standards:	Medical: EN60601-1-2, 4th edition Emissions: EN55032, EN61000-6-3, EN61000-6-4, CISPR11, CISPR22 Immunity: EN55024, EN61000-6-1, EN61000-6-2
Conducted Emissions:	Class B, FCC Part 15, Class B (with resistive load)
Radiated Emissions:	Class B, FCC Part 15, Class B (with resistive load)
Harmonic Current Voltage Distortion:	EN61000-3-2, Class A
Voltage Fluctuations/Flicker:	EN61000-3-3
Electrostatic Discharge (ESD) Immunity:	EN61000-4-2, 10KV contact discharge, 18KV air discharge
Radiated RF Immunity:	EN61000-4-3, 10V/m 80-1000MHz, 3V/m 1-2.7GHz, 80% 1KHz AM
EFT/Burst Immunity:	EN61000-4-4, 4KV/100kHz.
Line Surge Immunity:	EN61000-4-5, 2KV differential, 4KV common-mode
Conducted RF Immunity:	EN61000-4-6, 3VRMS, 80% 1KHz AM
Power Frequency Magnetic Field Immunity:	EN61000-4-8, 3A/m
Voltage Dip Immunity:	EN61000-4-11

Delivering leading edge, innovative power solutions for more than **30** years....

Model:GTM961200P120VV.V-T3

October 15, 2021

Enclosure

Housing:	High impact plastic, 94V0 polycarbonate, non-vented
Size:	149.4 * 62.6 * 33.5mm, ± 1.0mm
AC Input Mechanical Options:	C6, C8, C14, or C18 IEC inlet
Markings:	Label and/or pad printed and/or laser-etched into case

Special Options

1. Reduced leakage current to meet IEC60601-1 Type-CF limits
2. Improved EN61000-4-5 line surge immunity (3KV differential, 5KV common-mode)
3. Reduced harmonic current levels for LED lighting (EN61000-3-2 Class C) for 85 - 120W load
4. Short term output surge capability for motors or other high peak current loads
5. Ruggedized construction with improved shock and vibration resistance
6. Compliance to IPC-600, IPC-610, IPC-6012 Class 2 or 3
7. Custom cordsets, special cordage and connector types
8. Custom housing markings
9. Custom housing/cordage colors
10. Tightened output voltage tolerance
11. Reduced output ripple level
12. Reduced output power rating
13. Low temperature option, down to -40°C
14. Epoxy potted version "P2" or "P3" suffix, with flying wires or custom cables
15. "Back EMF" upgrade, for motor loads and other high inductance applications with reverse energy flow requirements
16. Improved ingress protection (IP) rating

Output Connectors

- Several output connector options are available with various output current ratings. GlobTek can supply 10A rated 2.1mm and 2.5mm style DC Power Jacks, to complement our 10A output rated 2.1mm and 2.5mm DC power plugs used on our output cordsets.
- Please visit our real-time listing of mating connector product offering:
<https://en.globtek.com/news/high-current-coaxial-barrel-plug-jacks-for-high-wattage-power-supplies>

Delivering leading edge, innovative power solutions for more than 30 years....

Model:GTM961200P120VV.V-T3

October 15, 2021

DERATING CURVE

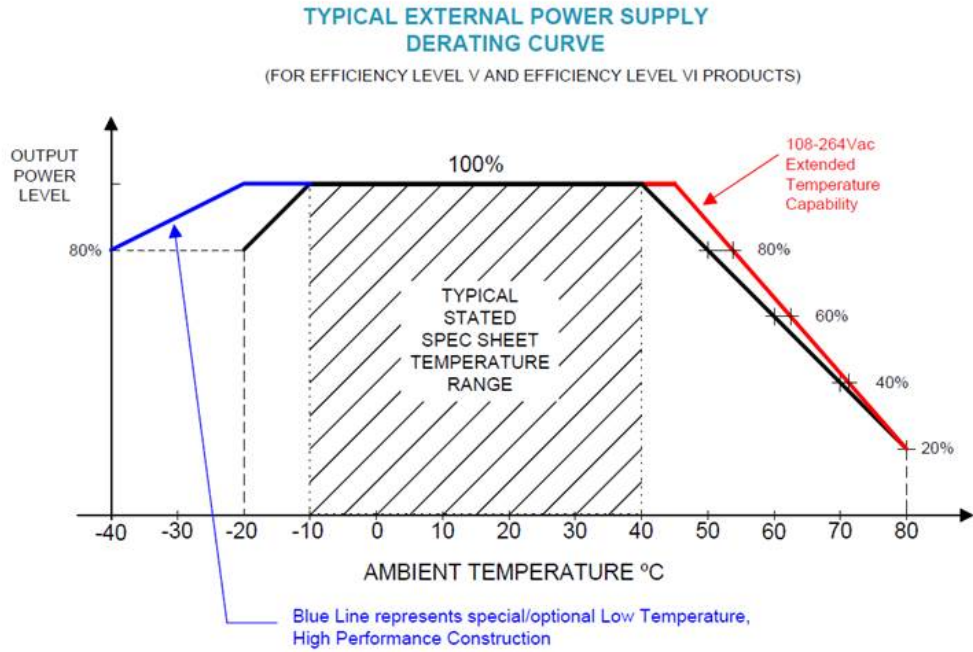

Delivering leading edge, innovative power solutions for more than 30 years....

Model:GTM961200P120VV.V-T3

October 15, 2021

INPUT CONFIGURATION

Description IEC 60320/C14 AC Inlet Connector, Class I, Earth Ground

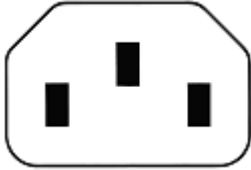

Mates with IEC 60320/C13 Plug

Optional Locking IEC60320 Receptacle and cord option available on some models by request.:

[Standard International IEC 320/C13 Cordsets](#)

Below are standard cordsets which are "not included" (unless stated above); these can be purchased separately or packaged with the power supply. Contact your Sales Engineer if the style required is not shown below. Many more available in different lengths, colors or cable material.

Stock Power Supply Cords

Part Number/ Link	Country	Plug	Termination	Length (mm)	(Ft)
3021457F701(R)	N. American (Type B)	NEMA 5-15P	IEC 320/C13	2150	7
1191068F0701(R)	N. American (Type B)	NEMA 5-15P Hospital	IEC 320/C13	2459	8
2194272M5701-T(R)	Argentina (Type I)	IRAM 2073	IEC 320/C13	2500	8
5502022M5701A(R)	Australian (Type I)	AS3112 / 3 PRONG	IEC 320/C13	2500	8
204B4272M5701(R)	Brazil (Type N)	BRAZIL	IEC 320/C13	2500	8
6023602M5701(R)	China (Type I)	CCC GR2099	IEC 320/C13	2500	8
G8014272M5701(R)	Danish (Type K)	AFSNIT SECTION 107-2-D1	IEC 320/C13	2500	8
23144272M5701-T(R)	Europe (Type E)	CEE 7/7	IEC 320/C13	2500	8
205IN4272M5701(R)	India (Type D)	India IS 1293 (also known as IA16A3 or BS546)	IEC 320/C13	2500	8
208IN4272M5701(R)	India (Type M)	India IS 1293 (also known as IA16A3 or BS546)	IEC320/C13	2500	8
377C4272M5701(R)	Israel (Type H)	ISL 377C	IEC 320/C13	2500	8
23024272M5701(R)	Italy (Type L)	CEI 23-16/VII	IEC 320/C13	2500	8
3003339F701(R) [3x1.25mm2]	Japan (Type B)	JIS 8303 / 3 PINS	IEC 320/C13	2500	8

PROPRIETARY INFORMATION

PROPRIETARY OF GLOBTEK, INC. ANY REPRODUCTION, DISCLOSURE OR USE OF THIS DRAWING, IN WHOLE OR IN PART, IS HEREBY PROHIBITED EXCEPT AS SPECIFIED IN WRITING BY GLOBTEK, INC.

<https://en.globtek.com/datasheet/id/a0Oa000000MjJKD>

Delivering leading edge, innovative power solutions for more than **30** years....

Model:GTM961200P120VV.V-T3

October 15, 2021

3003068F2701-HK(R) [3 x 2.0mm2]					
302J115J6F0701J(R)	Japan / North America (Type B – 12A)	JIS 8303 / 3 PINS and NEMA 5-15P (PSE and UL/CUL appr)	IEC 320/C13	1830	6
302J104J6F0701J(R)	Japan / North America (Type B – 15A)	JIS 8303 / 3 PINS and NEMA 5-15P (PSE and UL/CUL appr)	IEC 320/C13	1830	6
2313K3432M5701(R)	Korea (Type F)	KS C 8305	IEC 320/C13	2500	8
5804272M5701(R)	Russia (Type F)	GOST 7396	IEC 320/C13	2500	8
2084272M5701(R)	South Africa (Type M)	South Africa SABS164-1 (16A type)	IEC 320/C13	2500	8
23214272M5701(R)	Switzerland (Type J)	SEV 1011	IEC 320/C13	2500	8
3003322M5701(R)	Taiwan (Type B)	BSMI	IEC 320/C13	2500	8
PZ0800100-2M5BK13H(R)	UK, Hong Kong, Singapore, Gulf States (Type G)	BS 1363A	IEC 320/C13	2500	8
7055002M5701A(R)	International	IEC 320 C14-C13	IEC 320/C13	2500	8

Delivering leading edge, innovative power solutions for more than 30 years....

Model:GTM961200P120VV.V-T3

October 15, 2021

OUTPUT CONFIGURATION

Common output connector options:

 L Type (Coaxial
5.5x2.5mm plug)

 C Type (Coaxial
5.5x2.1mm plug)

 K Type (Coaxial
3.5x1.3mm plug)

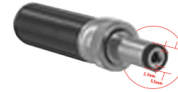
 LL Type (5.5x2.5mm
Locking 760k type)

 CL Type (5.5x2.1mm
Locking S761k type)

 ML2 Type (Molex
housing 43025-0200)

 YL3 Type
(KPPX-3P)

YL4 Type (KPPX-4P)

 EJ1/2/3/4/5 (EIAJ
RC-5320A type
connectors)

 MSB Type (Micro
USB)

 USBC Type (USB
Type C)

 Inquire for custom
design

 For a comprehensive list of options, [click here](#)



Contact GlobTek for your specific requirements or custom solutions.

Delivering leading edge, innovative power solutions for more than **30** years....

Model:GTM961200P120VV.V-T3

October 15, 2021





Approvals

Logo	Description
	Taiwan BSMI GTM961200P-T3(A) R32282 GTM961200P-T3(A); http://www.bsmi.gov.tw/wSite/ct?xItem=4072&ctNode=8167=2
No Logo Applicable	CB for IEC 60950-1:2005 (Second Edition) + Am 1:2009 + Am 2:2013
No Logo Applicable	CB for IEC 60601-1:2006/A1:2013+A12:2014 IEC 60601-1-11:2015
No Logo Applicable	CB for IEC 60335-1:2010 (Fifth Edition) incl. Corr. 1:2010 and Corr. 2:2011 + A1:2013
No Logo Applicable	IEC 60335-1.2010+A1
No Logo Applicable	CB for IEC61347-1:2015 + A1:2017 IEC61347-2-13:2014, A1:2016
No Logo Applicable	CB for IEC 62368-1:2014 (Second Edition)
	CCC Altitude up to 5000 m GB17625.1-2012, GB4943.1-2011, GB/T9254-2008
	Test standard: EN 55032: 2012+AC: 2013 EN 61000-3-2:2014 EN 61000-3-3:2013 EN 55024:2010 EN 60601-1-2:2015
	Audio/Video, Information And Communication Technology Equipment - Part 1: Safety Requirements [UL

Delivering leading edge, innovative power solutions for more than 30 years....

Model:GTM961200P120VV.V-T3

October 15, 2021

	62368-1:2014 Ed.2] Audio/Video, Information And Communication Technology Equipment - Part 1: Safety Requirements [CSA C22.2#62368-1:2014 Ed.2]
	CHINA SJ/T 11364-2014, China RoHS Chart: http://en.globtek.com/globtek-rohs.php
Conforms to AAMI STD.ES60601-1,IEC 60601-1-11 Certified to CAN/CSA STD.C22.2 NO.60601-1	Conforms to AAMI STD.ES60601-1,IEC 60601-1-11 Certified to CAN/CSA STD.C22.2 NO.60601-1
Conforms to UL STD. 60950-1 Certified to CSA STD C22.2 NO.60950-1	Conforms to UL STD. 60950-1 Certified to CSA STD C22.2 NO.60950-1
Conforms to UL STD. 62368-1 Certified to CSA STD C22.2 NO.62368-1	Conforms to UL STD. 62368-1 Certified to CSA STD C22.2 NO.62368-1
	Declaration ДС № EAЭC N RU Д-US.KA01.B.10453_19 Custom Union of Russia, Belarus and Kazakhstan http://www.globtek.com/redirect/?loc=gost-certificate-eac-declaration
	Medical Electrical Equipment - Part 1: General Requirements For Basic Safety And Essential Performance (R2012) [AAMI ES60601-1:2005 +C1;A2] [CSA C22.2#60601-1:2014 Ed.3] [AAMI HA60601-1-11:2015 Ed.2]
	Information Technology Equipment Safety Part 1: General Requirements >Valid without technical revision: 01Jan2022< [UL 60950-1:2007 Ed.2 +R:14Oct2014]
	ETL (Brazil) to IEC 62368-1;2014 DOC cert

Delivering leading edge, innovative power solutions for more than 30 years....

Model:GTM961200P120VV.V-T3







October 15, 2021

	<p>Bureau Of Indian Standards for GTM961200P12024-T3 24v only (pending)</p>
	<p>Indoor Use Only - Mark is on the label or Molded in the case</p>
 <p>DC-E-G71-005.1</p> <p>PRECAUCION: PARA USO EN EQUIPOS ELECTRONICOS SOLAMENTE</p>	<p>IRAM certificate DC-E-G71-005.1 to IEC 62368-1:2014</p>
<p>ITE כוח קצו</p>	<p>Electric strength Of Israel Standard SI 60950 Part 1 ? Safety of information technology equipment: General requirements, Feb. 2012. (GTM961200P12024-T3 Only) pending</p>
 <p>GlobTek, Inc.</p>	<p>JAPAN TUV R-PSE, Cert. No. JD 50469658, to J62368-1(H30) , J55032(H29),J3000(H25)[15V or less]. Please reference the following website for guidelines on PSE regulations: http://en.globtek.com/importing-ite-and-medical-power-supplies-ac-adaptors-to-japan/</p>
 <p>GlobTek, Inc.</p>	<p>JAPAN TUV R-PSE, Cert. No. JD 50469658, to J62368-1(H30) , J55032(H29),J3000(H25)[DC15?30V]. Please reference the following website for guidelines on PSE regulations: http://en.globtek.com/importing-ite-and-medical-power-supplies-ac-adaptors-to-japan/</p>
 <p>GlobTek, Inc.</p>	<p>JAPAN TUV R-PSE, Cert. No. JD 50469658, to J62368-1(H30) , J55032(H29),J3000(H25)[DC30?60V]. Please reference the following website for guidelines on PSE regulations: http://en.globtek.com/importing-ite-and-medical-power-supplies-ac-adaptors-to-japan/</p>

Delivering leading edge, innovative power solutions for more than 30 years....

Model:GTM961200P120VV.V-T3

October 15, 2021

 직류전원장치 AC/DC ADAPTER KTC HU10499-21046A R-R-GSZ-0006 전기용품안전관리법에 의한 표시 최저소비효율기준 만족 제품 모델명:GTM961200P10812-T3 <hr/> Mfr. Name: GLOBTEK (SUZHOU) CO.,LTD A/S Center:10-6221-6100	Korea KET KC Mark GTM961200P11012-T3(A) HU10499-21046A (12V & 13V Only)
 직류전원장치 AC/DC ADAPTER KTC HU10499-21048A R-R-GSZ-0011 전기용품안전관리법에 의한 표시 최저소비효율기준 만족 제품 모델명:GTM961200P12024-T3 <hr/> Mfr. Name: GLOBTEK (SUZHOU) CO.,LTD A/S Center:10-6221-6100	Korea KET KC Mark GTM961200P12024-T3 HU10499-21048A (24,25,26 and 27V Only)
EFFICIENCY LEVEL 	Efficiency: complies to section 301 of Energy Independence and Security Act (EISA) complies with Energy Star tier 2 (North America), ECP tier 2 (China), MEPS tier 2 (Australia), Code of Conduct (Europe)
No Logo	Malaysia ST Release Letter GTM961200P T2 T3(A) IEC62368-1(Ed.2): No logo
	Morocco SDoC declaration http://www.globtek.info/certs/Morocco%20SDoC%20Declaration/
	NOM MEXICO -ANCE FOR GTM961200P12024-T3 (24V)and GTM961200P11012-T3; GTM961200P10812-T3 (12V)
	Natural Resources Canada (NRCAN): CSA Standard C381.1-08, QSP NRCAN EEV1191; for model: GTM961200P10812-T3, -T3A, -T3TAB, -T2, -T2A, http://shop.csa.ca/en/canada/energy-efficiency/cancca-c3811-08/inv/27024802008
	RCM certificate SAA-170646-EA; Australia and New Zealand Regulatory Compliance, Mark (http://rcm.standards.org.au/rcmfaq/rcmfaq.htm)

PROPRIETARY INFORMATION









PROPRIETARY OF GLOBTEK, INC. ANY REPRODUCTION, DISCLOSURE OR USE OF THIS DRAWING, IN WHOLE OR IN PART, IS HEREBY PROHIBITED EXCEPT AS SPECIFIED IN WRITING BY GLOBTEK, INC.

<https://en.globtek.com/datasheet/id/a00a000000MjKD>

Delivering leading edge, innovative power solutions for more than 30 years....

Model:GTM961200P120VV.V-T3

October 15, 2021

RoHS	Specifications of directive 2011/65/EU Annex VI (ROHS-2) with amendment 2015/863-EU (ROHS-3) http://www.ce-mark.com/Rohs%20final.pdf
	S-Mark Certificate EN 60601-1:2006 + A1:2013 + A12:2014 EN 60601-1-11:2015 (http://www.intertek.com/marks/s/)
	S-Mark Certificate EN 60950-1:2006 + A11:2009 + A1:2010 + A12:2011+A2:2013 (http://www.intertek.com/marks/s/)
	S-Mark Certificate EN 62368-1:2014 + A11 (http://www.intertek.com/marks/s/)
	Serial Number Information
	Singapore to IEC 62368 (for 24V only)
	UKCA Certification
	Ukraine UKRSeuro (Document: www.globtek.com/html/iso_certificates/GT_Ukraine.pdf)
	Japan: Voluntary Control Council for Interference (VCCI)
	WEEE: Complies with EU 2012/19/EU (http://ec.europa.eu/environment/waste/wEEE/index_en.htm) Mark is on the label or Molded in the case